

elevate your flexibility

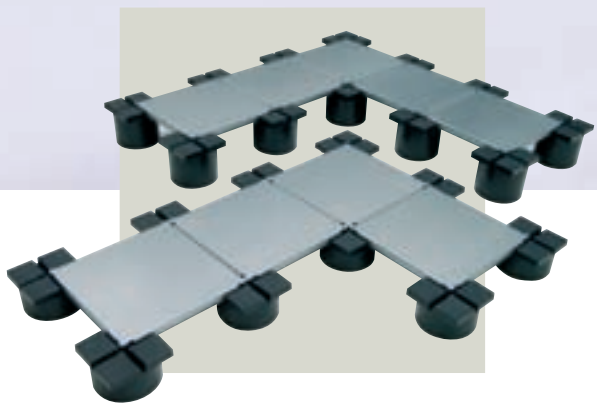

SOLUFLEX CABLE MANAGEMENT
FLOOR SYSTEM / PRODUCT GUIDE

 **legrand**[®]

www.legrand.co.uk

Global vision...

21st Century solutions

Why choose Legrand?

In a word, confidence. Legrand is a world leader in its field, with offices and subsidiaries in more than 60 countries and sales in close to 180 countries. Globally, Legrand holds 19% of the wiring devices market and 15% of the cable management market.

Innovation for progress

Legrand invests heavily in research and development. It has around 1,800 people throughout the world inventing, designing, testing and validating new ideas.

By actively focusing on new product development, Legrand is able to launch new ranges that are packed with innovative features to facilitate installation for the contractor and simplify usage for the end user.

Sustainable development

Legrand relies heavily on its core values and on the expertise of its teams to ensure profitable, long-lasting and responsible growth... combining long-term performance with environmental conservation and the valuing of human resources.



Soluflex... sustainable by design

Steel is the most sustainable material used in construction today and therefore one of the best ways for us to avoid problems for generations to come.

Constructed from steel tiles with recycled polypropylene supports, Soluflex requires nothing else for installation... no glue, no fixings.

The result is a system that is 100% recyclable and that can be reconfigured again and again to meet changing requirements in evolving commercial environments.



Offices



Hotels



Retail

Contents

Introduction	04
Systems overview	08
Integration	10
Selection chart	12
37 mm system	14
60 mm system	16
90 mm system	18
120 mm system	20
Technical information	22
Dimensions	25
Power track	30



Residential



Industrial

Using global strength and local knowledge to provide solutions to today's needs

Soluflex... paving the way with integrated cable management

Legrand's latest development, Soluflex, is much more than just a raised floor. This innovative new system integrates low-level flooring with Legrand's market leading cable management solutions.

All cables for power, data, and telecoms can be structured in a logical, ready to use layout that remains hidden to end users.

Quick and easy installation

You don't have to be a flooring expert to install Soluflex. It's simply a question of placing supports on the floor and then clicking the durable steel tiles into place (without the need for glue or fixings).

Once the floor has been laid, the required cabling and connections can be installed between the supports by removing the relevant tiles until cabling is complete. The finished installation can then be covered with any type of covering... carpet tiles, rubber, stone or wood. And if the office layout changes, or even relocates, Soluflex can be reconfigured and re-used.

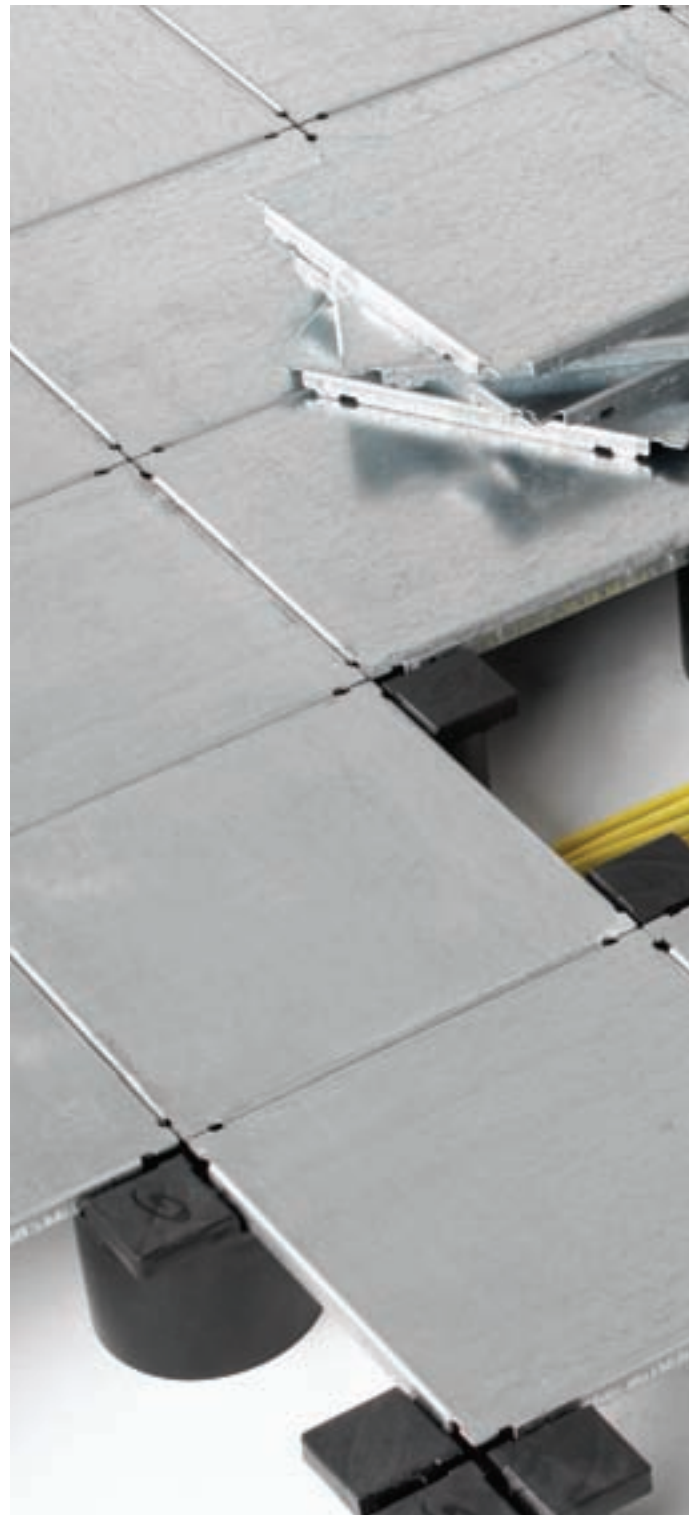

Simple clip together assembly without the need for fixings or adhesives



Complete system with a wide range of accessories and access solutions



Easy access to power and data with built-in cavity floor boxes

fast, flexible
solutions for
floors



4 standard heights to meet the needs of any installation...
each with bespoke solutions for access to power and data

Freedom of design

Soluflex creates well organised, multifunctional rooms where users will always have enough connection points. At the design stage, it's no longer necessary to keep track of the connection points for power and data. The cabling can be installed anywhere under the entire floor and the location of connections can be determined at any stage.

Save time. Save money

Soluflex offers considerable time-saving as floors and cables can be installed virtually simultaneously.

The supports and tiles are wear-resistant, offering long-term savings.

Adding or restructuring connection points can be done in a matter of minutes, without cutting or breaking cables... often without the need to shut down power or data.

Ideal for renovation

Ideal for use in existing buildings, Soluflex's non-invasive installation technique avoids damaging historic floors and includes a specially developed, ultra-low 37 mm system... the perfect lightweight solution to bring older buildings into the 21st century without compromising floor to ceiling height.

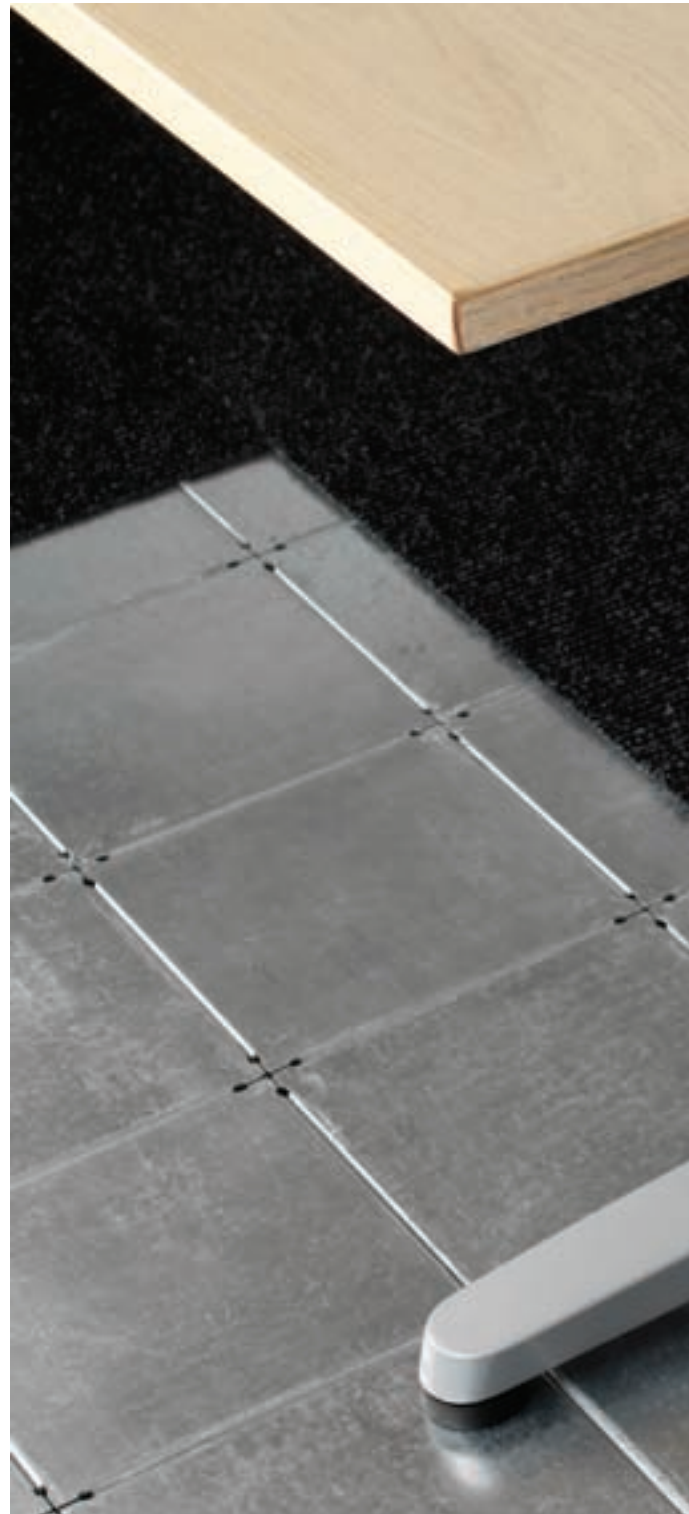

Whether modern or traditional, commercial installations demand flexibility... something that the new **Soluflex® cable management floor system** takes in its stride, offering endless cabling potential for the future.



Modern commercial developments



Traditional / refurbishment projects

power pole
with Synergy
matt black
accessories



Suitable for any size of installation



Flexible configuration

The choice is yours

Combining cable management and flooring has never been easier. Choose from four low-level access flooring systems that can be instantly reconfigured to meet changing power and data needs.

■ Soluflex : 37 mm

Ideal for refurbishment where floor to ceiling space is limited.

The 37 mm version has been developed with renovation in mind... allowing old buildings to be brought up-to-date without affecting their traditional feel. The system enables all cabling to be installed in a compact void.

Power can be accessed from specially designed, flush mounting socket outlets, or by using cable snakes and power poles that are fed directly with power and data cables from under the floor.

■ Soluflex : 60 mm

Low level floor with underfloor power access.

In addition to the power and data solutions associated with the shallowest system, the 60 mm system also incorporates a twin socket outlet that allows electrical devices to be connected under the floor.

With a wide range of underfloor and surface mounted accessories, power, data and telecoms can be configured to meet bespoke requirements and can also be ordered from a selection of pre-wired options.

■ Soluflex : 90 and 120 mm

Increased cabling space, maximum options.

The 90 mm and 120 mm systems include enough room for bulk cabling and outlet units. Various floor boxes are available in pre-wired and configurable formats to include any combination of power, data and even RCD protection.

Built-in tiles are available to accept floor boxes. As with all the systems, there is also a wide selection of surface mounted options for power and data.



Four depths to meet installation requirements... simplicity, sustainability and flexibility

■ Access all areas

Where doors prevent elevation of the floor, or where disabled access is required, Soluflex ramps can be used to change from one floor height to another.

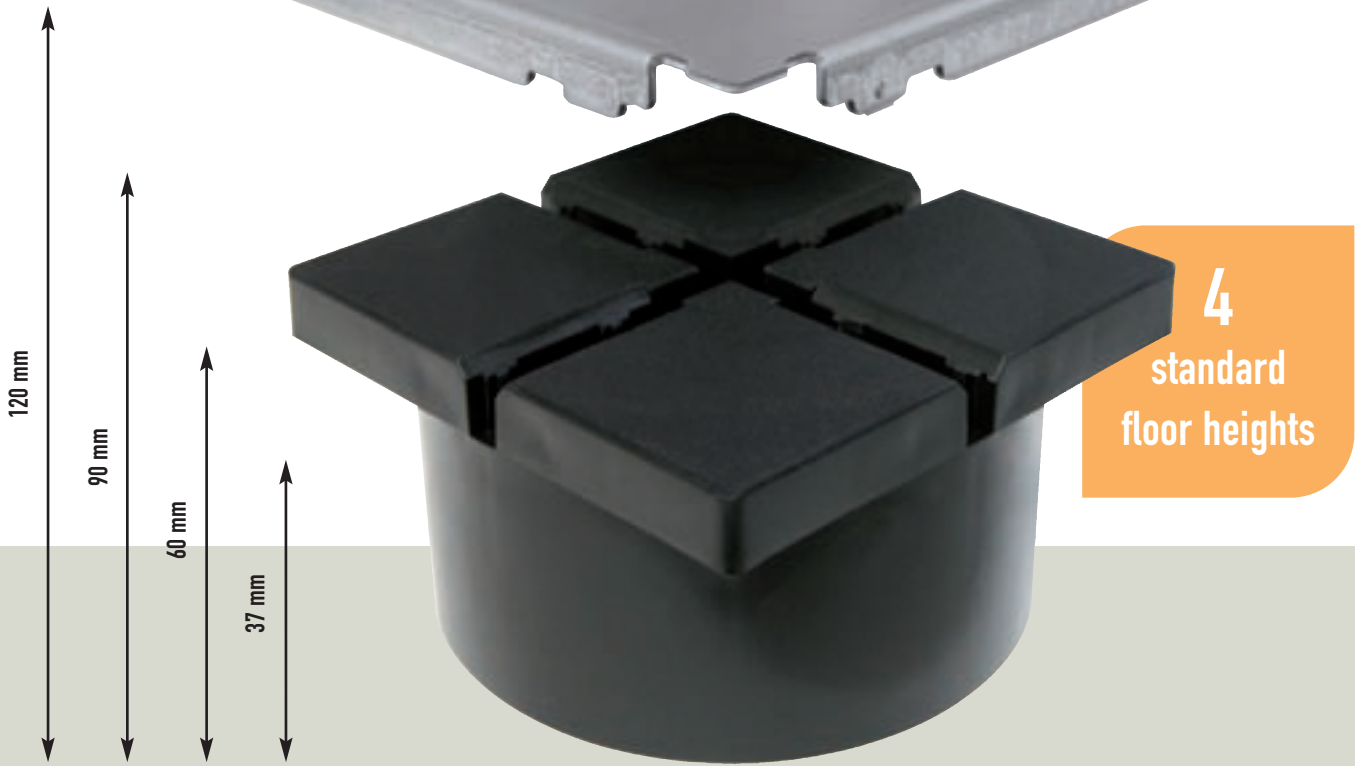

Summary of technical characteristics

Materials

- The tiles are made of pre-galvanised sheet steel.
- The supports are made of recycled polypropylene.

Safety

- Short circuits : Soluflex is earthed (as long as 1 earthing tile is installed per 100 m²).
- Fire resistance : Due to its low plenum height, the cable floor system is self-extinguishing. Tested according to BS EN 13501-1, class B(fl)S1-d0.

Weights and measures

- Dimensions of tiles : 225 x 225 mm, thickness 2 mm.
- Weight : approx. 20 kg per m².
- Point load per tile/support : 1500 Newton/25 mm².
- Uniformly distributed load of 3000 kg per m².

Acoustic

Flanking airborne sound insulation in accordance with ISO 717-1 : 1996

- Soluflex cable management floor system + carpet tiles, without mineral wool underneath the partition wall : $D_{n,f,w} = 48$ dB

Flanking impact sound insulation in accordance with ISO 717-2 : 1996

- Soluflex cable management floor system + carpet tiles, without mineral wool underneath the partition wall : $L_{n,f,w} = 49$ dB

Vertical impact sound insulation improvement in accordance with ISO 717-2 : 1996

- Tested in accordance with ISO 140-8 : 1978 Concrete floor 140 mm + Soluflex + carpet tiles
 $\Delta L_w = 24$ dB $\Delta l_{lin} = 12$ dB

Other characteristics

- The Soluflex cable management floor system feels extremely solid. Since the system is not adjustable in height, it needs no later adjustment.
- The grid layout of the system means the cables are perfectly parallel, and you can cross data cables at the required angle of 90°.

Integration... the perfect partners

Soluflex has been designed to integrate perfectly with Legrand's market leading cable management solutions and wiring devices...

From ultra-compact power track systems to steel wire cable tray, and from cavity floor boxes to Mosaic power and data sockets, every solution can be installed in or under the floor.

For complete flexibility of use, Soluflex can be integrated with a **wide range of power and data accessories** that are ideal for the changing needs of today's offices and commercial installations



Cable snake : direct access to floor services



Slab box : RCD protection



Flush mounting socket : ideal solution for cleaner sockets

the UK's leader
in cable
management



Underfloor twin socket : prevents accidental unplugging



Floor boxes : wide selection of bespoke or pre-wired units

Soluflex® cable floor system selection chart

Height (mm)	Tile	Support	Double edge plate	Single edge plate	Step	Step corner	Ramp	Earthing tile
37	84000 10	84037 00	84000 60	84000 61	84037 22	84037 30	84037 40	84000 20
60	84000 10	84060 00	84000 60	84000 61	84060 22	84060 30	84060 40	84000 20
90	84000 10	84090 00	84000 60	84000 61	84090 22	84090 30	84090 40	84000 20
120	84000 10	84120 00	84000 60	84000 61	84120 22	84120 30	84120 40	84000 20

Height (mm)	Floor box tile	Floor box lid + trim	3 comp. twin socket module	4 comp. twin socket module	3 comp. blank module	4 comp. blank module	3 comp. data module	4 comp. data module
37	—	—	—	—	—	—	—	—
60	84090 81	8218 21	8218 22	8218 23	8218 24	8218 25	8218 26	8218 27
90	84090 81	8218 21	8218 22	8218 23	8218 24	8218 25	8218 26	8218 27
120	84090 81	8218 21	8218 22	8218 23	8218 24	8218 25	8218 26	8218 27

■ **Floor boxes with lid & trim assemblies :**

Suitable for 60, 90 and 120 mm systems

Specials also available, including RCD and RCBO options to comply with 17th Edition requirements



	Cable outlet tile	Chrome outlet grommet	Accessory outlet tile	Fixing bracket	Built-in Mosaic power unit 2 x 240 V (empty)	Built-in Mosaic data unit 2 x 2 data (empty)	Fully submerged Mosaic power unit 2 x 240 V (empty)	Fully submerged Mosaic data unit 2 x 2 data (empty)
	84000 30	81902 32	84000 40	84000 50	84037 50	84037 51	–	–
	84000 30	81902 32	84000 40	84000 50	–	–	84060 72	84060 73
	84000 30	81902 32	84000 40	84000 50	–	–	–	–
	84000 30	81902 32	84000 40	84000 50	–	–	–	–

	RCD slab box	Single socket outlet tile	Brushed chrome floor plate ⁽¹⁾	Polished chrome floor plate ⁽¹⁾	Satin brass chrome floor plate ⁽¹⁾	Cable snake – grey ⁽²⁾	Cable snake – black ⁽²⁾	Power pole ⁽³⁾
	–	–	7331 97	7333 97	7335 97	81906 40	81906 41	86502 10
	8218 29	8218 28	7331 97	7333 97	7335 97	81906 40	81906 41	86502 10
	8218 29	8218 28	7331 97	7333 97	7335 97	81906 40	81906 41	86502 10
	8218 29	8218 28	7331 97	7333 97	7335 97	81906 40	81906 41	86502 10

(1) For use with single socket outlet tile. Shown with Mosaic 13 A socket, Cat. No. 0741 40 (order separately). For the full range of Mosaic options, please refer to the current Legrand catalogue

(2) For use with accessory outlet tile or cable outlet tile

(3) For use with accessory outlet tile. Standard version shown. Requires back box, Cat. No. 8218 30. Other configurations available to special order. Contact us on 0845 605 4333

■ Cable snake

The cable snake creates neat, tidy work spaces by concealing cables between the floor and the desk. For more information, contact us on 0845 605 4333



■ Power pole

Multiple configurations available to special order. Contact us on 0845 605 4333



Soluflex® cable floor system

37 mm height

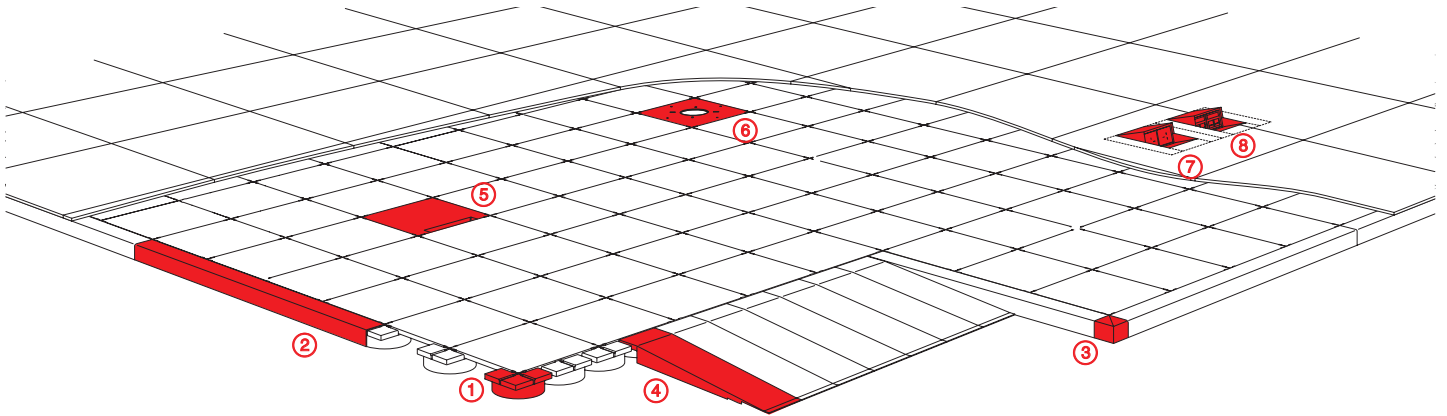

Selection table (page 12–13)
Installation instructions (page 24)
Dimensions (page 25)

Pack	Cat. Nos.	Floor parts	Pack	Cat. Nos.	Floor parts (continued)
1	84000 10	Tile Pre-galvanised 225 mm x 225 mm Height 13 mm Provided with 4 contact/distance projections	1	84000 20	Earthing tile Pre-galvanised 225 mm x 225 mm Height 13 mm Earthing clamp 6 mm ² (max.) 1 tile per 100 m ² or in gangways max. 14 metres apart Provided with 4 contact/distance projections
1	84037 00	Support ① Black Polypropylene 100 mm x 100 mm With 2 grooves in which tiles can be positioned	1	84000 30	Cable outlet tile ⑤ Pre-galvanised 225 mm x 225 mm Height 13 mm Access 125 x 15 mm For cable access to work station Provided with 4 contact/distance projections
1	84000 60	Double edge plate Pre-galvanised Length 900 mm, width 300 mm 2 x turned sides of 13 mm Used to finish installation against wall Trim to size on site	1	81902 32	Chrome outlet grommet Chromed Apply with accessory outlet tile Cat. No. 84000 40 For cable access to work station
1	84000 61	Single edge plate Pre-galvanised Length 900 mm, width 300 mm 1 x turned side of 13 mm Used to finish installation against wall Trim to size on site	1	84000 40	Accessory outlet tile ⑥ Pre-galvanised 225 mm x 225 mm Height 13 mm For power poles, pedestals + cable snake (contact us on 0845 605 4333) and chrome outlet grommet (Cat. No. 81902 32) Provided with 4 contact/distance projections
1	84037 22	Step ② Pre-galvanised Height 37 mm, length 900 mm, width 56 mm For edging the floor to create a step	1	84000 50	Fixing bracket Pre-galvanised For mounting column (contact us on 0845 605 4333) on to the floor with accessory outlet tile Cat. No. 84000 40
1	84037 30	Step corner ③ Pre-galvanised 56 x 56 mm Use in conjunction with 84037 22			
1	84037 40	Ramp ④ Pre-galvanised Ramp 10% Length 400 mm, width 112 mm Include 1 extra support Cat. No. 84037 00 per tile			

Soluflex® cable floor system

37 mm height (continued)

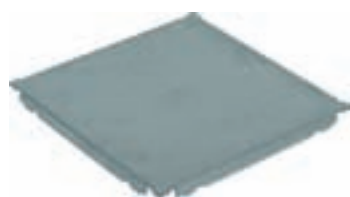

84000 10



84037 00

Pack	Cat. Nos.	Floor parts (continued)
1	84037 50	Built-in Mosaic power unit 2 x 240 V (empty) ⑦ Pre-galvanised Square 225 mm, height 37 mm (accessory outlet rises to 71 mm) Provided with connection terminal and strain relief Pre-wirable for 2 x Mosaic 13 A socket outlets
1	84037 51	Built-in Mosaic data unit 2 x 2 data (empty) ⑧ Pre-galvanised Square 225 mm, height 37 mm (accessory outlet rises to 71 mm) Accepts up to four Mosaic data outlets
1	8218 28	Single socket outlet tile
1	7331 97	Brushed chrome floor plate⁽¹⁾
1	7333 97	Polished chrome floor plate⁽¹⁾
1	7335 97	Satin brass chrome floor plate⁽¹⁾
		Cable snake
1	81906 40	Grey
1	81906 41	Black
		Power pole
1	86502 10	
		Power pole backbox
1	8218 30	

Soluflex® cable floor system

mounting drawings

37 mm height

■ Installation examples

Power pole with accessory outlet tile and fixing bracket

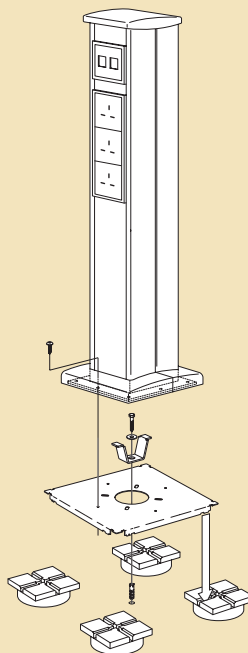

Positioning of power outlet units

Positioning of data outlet units

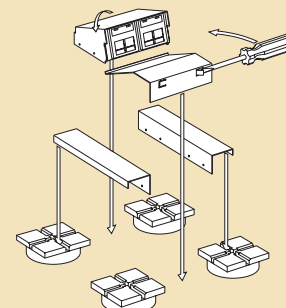
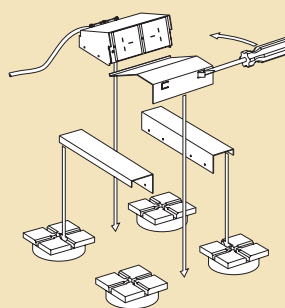

(1) For use with single socket outlet tile. Shown with Mosaic 13 A socket, Cat. No. 0741 40 (order separately). For the full range of Mosaic options, please refer to the current Legrand catalogue

Soluflex® cable floor system

60 mm height

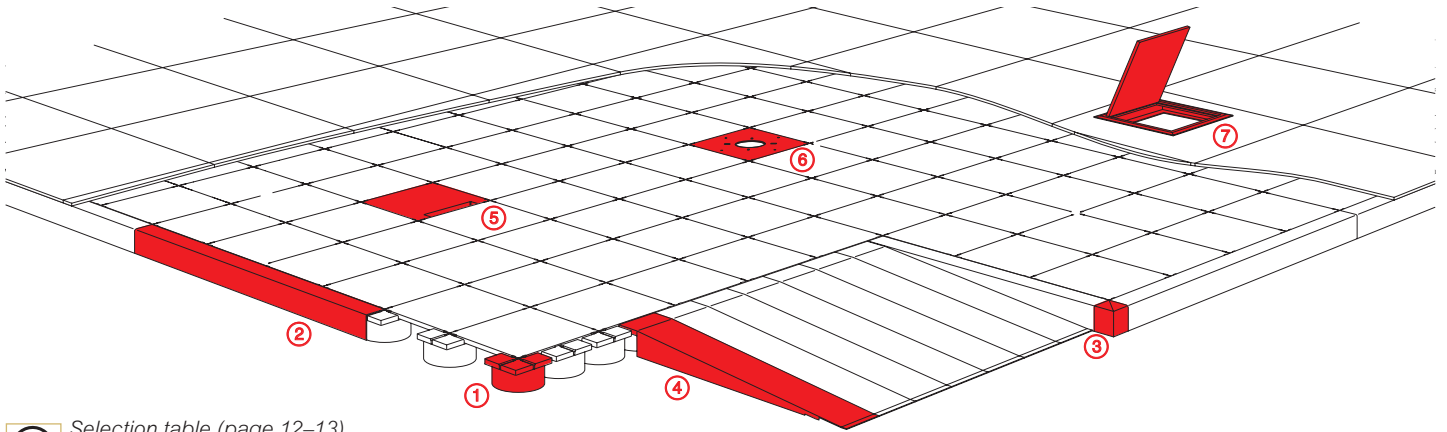

Selection table (page 12–13)
Installation instructions (page 24)
Dimensions (page 26)

Pack	Cat. Nos.	Floor parts	Pack	Cat. Nos.	Floor parts (continued)
1	84000 10	Tile Pre-galvanised 225 mm x 225 mm Height 13 mm Provided with 4 contact/distance projections	1	84000 20	Earthing tile Pre-galvanised 225 mm x 225 mm Height 13 mm Earthing clamp 6 mm ² (max.) 1 tile per 100 m ² or in gangways max. 14 metres apart Provided with 4 contact/distance projections
1	84060 00	Support ① Black Polypropylene 100 mm x 100 mm With 2 grooves in which tiles can be positioned	1	84000 30	Cable outlet tile ⑤ Pre-galvanised 225 mm x 225 mm Height 13 mm Access 125 x 15 mm For cable access to work station Provided with 4 contact/distance projections
1	84000 60	Double edge plate Pre-galvanised Length 900 mm, width 300 mm 2 x turned sides of 13 mm Used to finish installation against wall Trim to size on site	1	81902 32	Chrome outlet grommet Chromed Apply with accessory outlet tile Cat. No. 84000 40 For cable access to work station
1	84000 61	Single edge plate Pre-galvanised Length 900 mm, width 300 mm 1 x turned side of 13 mm Used to finish installation against wall Trim to size on site	1	84000 40	Accessory outlet tile ⑥ Pre-galvanised 225 mm x 225 mm Height 13 mm For power poles, pedestals + cable snake (contact us on 0845 605 4333) and chrome outlet grommet (Cat. No. 81902 32) Provided with 4 contact/distance projections
1	84060 22	Step ② Pre-galvanised Height 60 mm, length 900 mm, width 56 mm For edging the floor to create a step	1	84000 50	Fixing bracket Pre-galvanised For mounting column (contact us on 0845 605 4333) on to the floor with accessory outlet tile Cat. No. 84000 40
1	84060 30	Step corner ③ Pre-galvanised 56 x 56 mm Use in conjunction with 84037 22	1	84060 72	Fully submerged Mosaic power unit 2 x 240 V (empty) Pre-galvanised Provided with connection terminal Pre-wirable for 2 x Mosaic built-in Combine with cable outlet tile Cat. No. 84000 30
1	84060 40	Ramp ④ Pre-galvanised Ramp 10% Length 616 mm, width 112 mm Include 1 extra support Cat. No. 84037 00 per tile	1	84060 73	Fully submerged Mosaic data unit 2 x 2 data Pre-galvanised For built-in double Mosaic data Combine with cable outlet tile Cat. No. 84000 30

Soluflex® cable floor system

60 mm height (continued)

Soluflex® cable floor system

mounting drawings

60 mm height

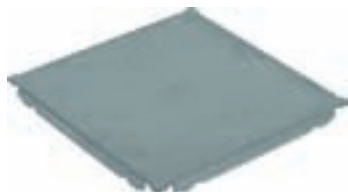

84000 10



84060 00

Pack	Cat. Nos.	Floor parts (continued)
------	-----------	-------------------------

1	84090 81	Floor box tile Pre-galvanised 450 mm x 450 mm For lid + trim assembly Cat. No. 8218 21 Including wooden disposable cover	
1	8218 21	Floor box lid + trim ⓘ Plastic with carpet edge Combine with Cat. No. 84090 81 and outlet options below	
1	8218 22	3 comp. twin socket module	
1	8218 23	4 comp. twin socket module	
1	8218 24	3 comp. blank module	
1	8218 25	4 comp. blank module	
1	8218 26	3 comp. data module	
1	8218 27	4 comp. data module	
1	8218 28	Single socket outlet tile	
1	7331 97	Brushed chrome floor plate ⁽¹⁾	
1	7333 97	Polished chrome floor plate ⁽¹⁾	
1	7335 97	Satin brass chrome floor plate ⁽¹⁾	
1	8218 29	RCD slab box	
		Cable snake	
1	81906 40	Grey	
1	81906 41	Black	
1	86502 10	Power pole	
1	8218 30	Power pole backbox	

Installation examples

Power pole with accessory outlet tile and fixing bracket

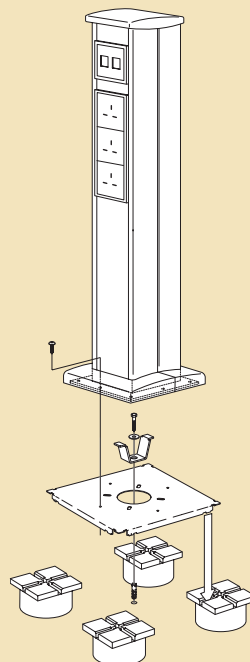

Submerged Mosaic power unit with cable outlet tile

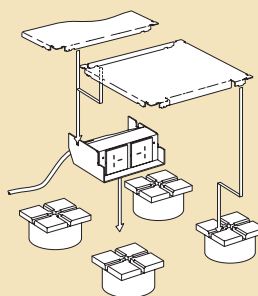

Fully submerged Mosaic data unit with cable outlet

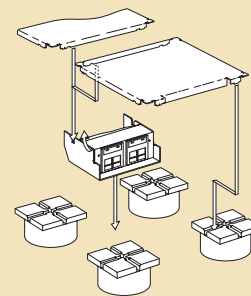

Floor box lid and trim with floor box tile

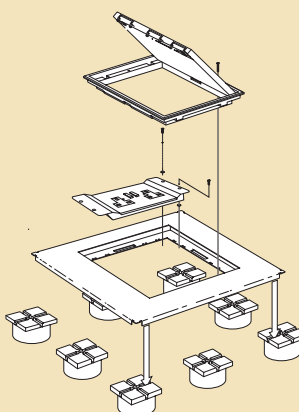

(1) For use with single socket outlet tile. Shown with Mosaic 13 A socket, Cat. No. 0741 40 (order separately). For the full range of Mosaic options, please refer to the current Legrand catalogue

Soluflex® cable floor system

90 mm height

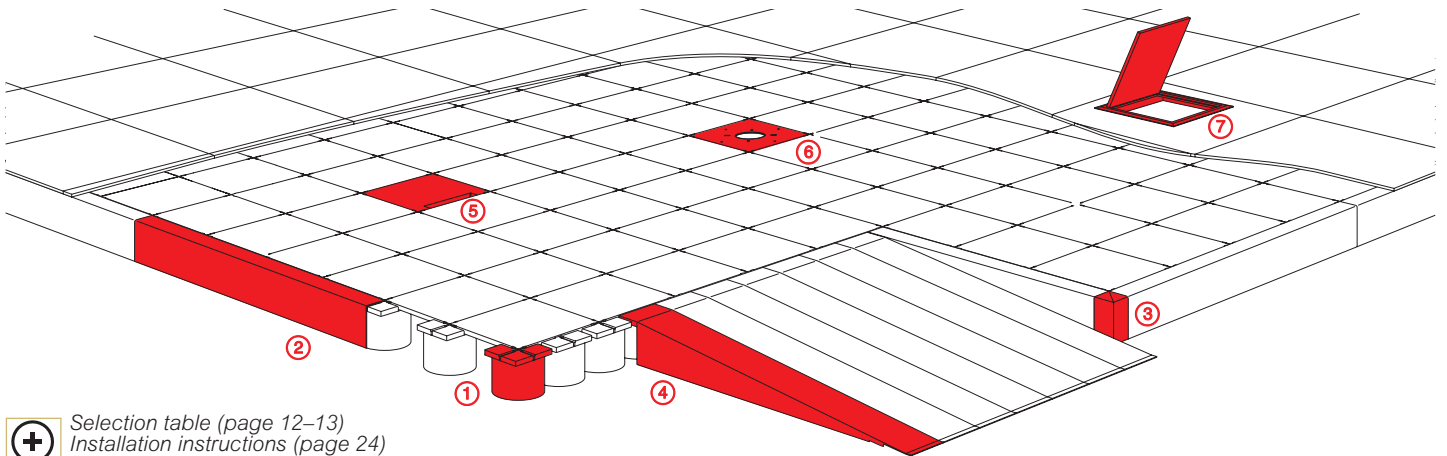

Selection table (page 12–13)
Installation instructions (page 24)
Dimensions (page 28)

Pack	Cat. Nos.	Floor parts	
1	84000 10	Tile Pre-galvanised 225 mm x 225 mm Height 13 mm Provided with 4 contact/distance projections	
1	84060 00	Support ① Black Polypropylene 100 mm x 100 mm With 2 grooves in which tiles can be positioned	
1	84000 60	Double edge plate Pre-galvanised Length 900 mm, width 300 mm 2 x turned sides of 13 mm Used to finish installation against wall Trim to size on site	
1	84000 61	Single edge plate Pre-galvanised Length 900 mm, width 300 mm 1 x turned side of 13 mm Used to finish installation against wall Trim to size on site	
1	84090 22	Step ② Pre-galvanised Height 60 mm, length 900 mm, width 56 mm For edging the floor to create a step	
1	84090 30	Step corner ③ Pre-galvanised 56 x 56 mm Use in conjunction with 84037 22	
1	84090 40	Ramp ④ Pre-galvanised Ramp 10% Length 898 mm, width 112 mm Include 1 extra support Cat. No. 84037 00 per tile	

Pack	Cat. Nos.	Floor parts (continued)	
1	84000 20	Earthing tile Pre-galvanised 225 mm x 225 mm Height 13 mm Earthing clamp 6 mm ² (max.) 1 tile per 100 m ² or in gangways max. 14 metres apart Provided with 4 contact/distance projections	
1	84000 30	Cable outlet tile ⑤ Pre-galvanised 225 mm x 225 mm Height 13 mm Access 125 x 15 mm For cable access to work station Provided with 4 contact/distance projections	
1	81902 32	Chrome outlet grommet Chromed Apply with accessory outlet tile Cat. No. 84000 40 For cable access to work station	
1	84000 40	Accessory outlet tile ⑥ Pre-galvanised 225 mm x 225 mm Height 13 mm For power poles, pedestals + cable snake (contact us on 0845 605 4333) and chrome outlet grommet (Cat. No. 81902 32) Provided with 4 contact/distance projections	
1	84000 50	Fixing bracket Pre-galvanised For mounting column (contact us on 0845 605 4333) on to the floor with accessory outlet tile Cat. No. 84000 40	

Soluflex® cable floor system

90 mm height (continued)

Soluflex® cable floor system

mounting drawings

90 mm height

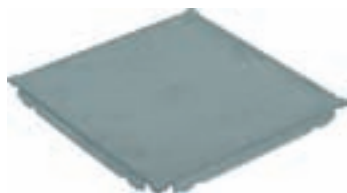

84000 10



84090 00

Pack	Cat. Nos.	Floor parts (continued)
1	84090 81	Floor box tile Pre-galvanised 450 mm x 450 mm For lid + trim assembly Cat. No. 8218 21 Including wooden disposable cover
1	8218 21	Floor box lid + trim ⓘ Plastic with carpet edge Combine with Cat. No. 84090 81 and outlet options below
1	8218 22	3 comp. twin socket module
1	8218 23	4 comp. twin socket module
1	8218 24	3 comp. blank module
1	8218 25	4 comp. blank module
1	8218 26	3 comp. data module
1	8218 27	4 comp. data module
1	8218 28	Single socket outlet tile
1	7331 97	Brushed chrome floor plate ⁽¹⁾
1	7333 97	Polished chrome floor plate ⁽¹⁾
1	7335 97	Satin brass chrome floor plate ⁽¹⁾
1	8218 29	RCD slab box
1	81906 40	Cable snake Grey
1	81906 41	Black
1	86502 10	Power pole
1	8218 30	Power pole backbox

Floor box tile

Pre-galvanised
450 mm x 450 mm
For lid + trim assembly
Cat. No. 8218 21
Including wooden disposable cover

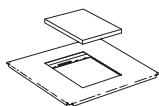

Floor box lid + trim ⓘ

Plastic with carpet edge
Combine with Cat. No. 84090 81 and
outlet options below



3 comp. twin socket module

4 comp. twin socket module

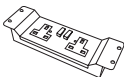

3 comp. blank module

4 comp. blank module

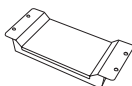

3 comp. data module

4 comp. data module

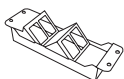

Single socket outlet tile



Brushed chrome floor plate⁽¹⁾

Polished chrome floor plate⁽¹⁾

Satin brass chrome floor plate⁽¹⁾



RCD slab box

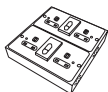

Cable snake

Grey

Black



Power pole

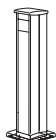

Power pole backbox



Installation examples

Power pole with accessory outlet tile and fixing bracket

Floor box lid and trim with floor box tile

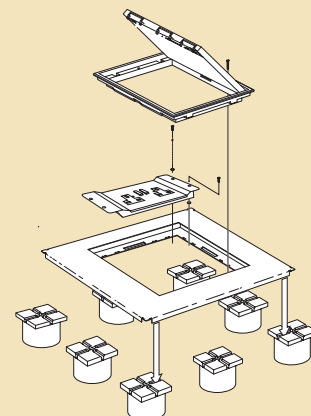
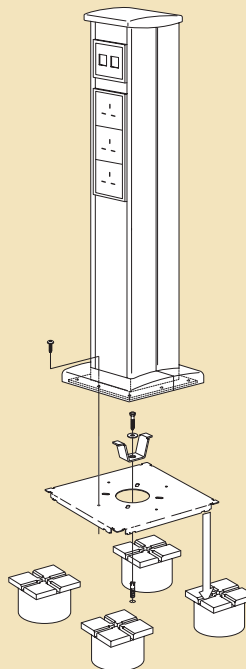

(1) For use with single socket outlet tile. Shown with Mosaic 13 A socket, Cat. No. 0741 40 (order separately). For the full range of Mosaic options, please refer to the current Legrand catalogue

Soluflex® cable floor system

120 mm height

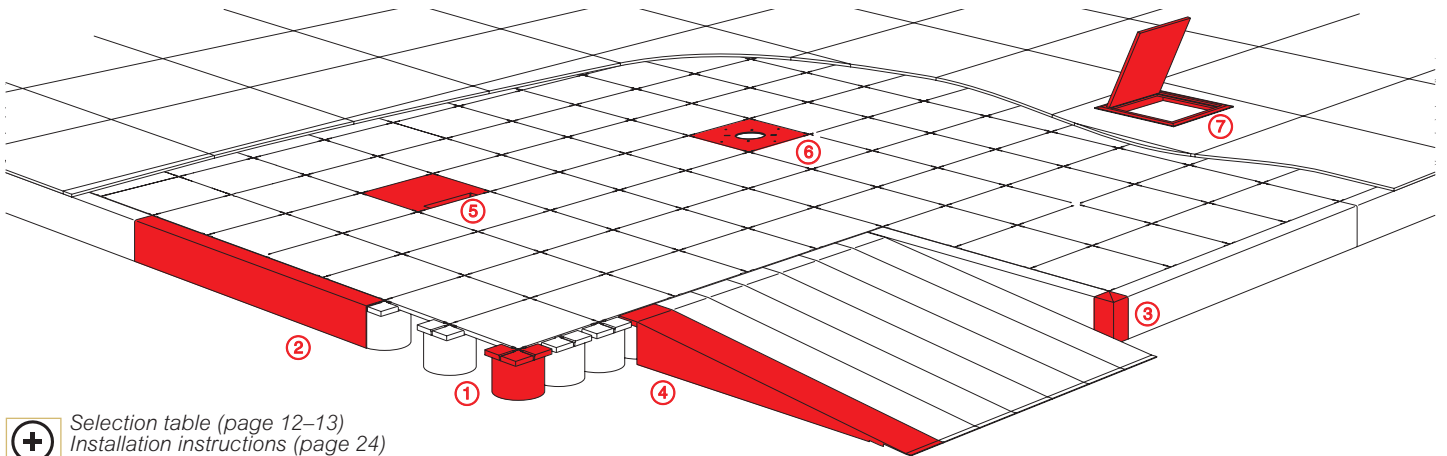

Selection table (page 12–13)
Installation instructions (page 24)
Dimensions (page 29)

Pack	Cat. Nos.	Floor parts	Pack	Cat. Nos.	Floor parts (continued)
1	84000 10	Tile Pre-galvanised 225 mm x 225 mm Height 13 mm Provided with 4 contact/distance projections	1	84000 20	Earthing tile Pre-galvanised 225 mm x 225 mm Height 13 mm Earthing clamp 6 mm ² (max.) 1 tile per 100 m ² or in gangways max. 14 metres apart Provided with 4 contact/distance projections
1	84120 00	Support ① Black Polypropylene 100 mm x 100 mm With 2 grooves in which tiles can be positioned	1	84000 30	Cable outlet tile ⑤ Pre-galvanised 225 mm x 225 mm Height 13 mm Access 125 x 15 mm For cable access to work station Provided with 4 contact/distance projections
1	84000 60	Double edge plate Pre-galvanised Length 900 mm, width 300 mm 2 x turned sides of 13 mm Used to finish installation against wall Trim to size on site	1	81902 32	Chrome outlet grommet Chromed Apply with accessory outlet tile Cat. No. 84000 40 For cable access to work station
1	84000 61	Single edge plate Pre-galvanised Length 900 mm, width 300 mm 1 x turned side of 13 mm Used to finish installation against wall Trim to size on site	1	84000 40	Accessory outlet tile ⑥ Pre-galvanised 225 mm x 225 mm Height 13 mm For power poles, pedestals + cable snake (contact us on 0845 605 4333) and chrome outlet grommet (Cat. No. 81902 32) Provided with 4 contact/distance projections
1	84120 22	Step ② Pre-galvanised Height 60 mm, length 900 mm, width 56 mm For edging the floor to create a step	1	84000 50	Fixing bracket Pre-galvanised For mounting column (contact us on 0845 605 4333) on to the floor with accessory outlet tile Cat. No. 84000 40
1	84120 30	Step corner ③ Pre-galvanised 56 x 56 mm Use in conjunction with 84037 22			
1	84120 40	Ramp ④ Pre-galvanised Ramp 10% Length 1181 mm, width 112 mm Include 1 extra support Cat. No. 84037 00 per tile			

Soluflex® cable floor system

120 mm height (continued)

Soluflex® cable floor system

mounting drawings

120 mm height

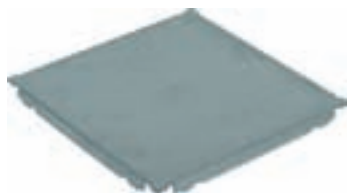

84000 10



84120 00

Pack	Cat. Nos.	Floor parts (continued)	
1	84090 81	Floor box tile Pre-galvanised 450 mm x 450 mm For lid + trim assembly Cat. No. 8218 21 Including wooden disposable cover	
1	8218 21	Floor box lid + trim ⓘ Plastic with carpet edge Combine with Cat. No. 84090 81 and outlet options below	
1	8218 22	3 comp. twin socket module	
1	8218 23	4 comp. twin socket module	
1	8218 24	3 comp. blank module	
1	8218 25	4 comp. blank module	
1	8218 26	3 comp. data module	
1	8218 27	4 comp. data module	
1	8218 28	Single socket outlet tile	
1	7331 97	Brushed chrome floor plate ⁽¹⁾	
1	7333 97	Polished chrome floor plate ⁽¹⁾	
1	7335 97	Satin brass chrome floor plate ⁽¹⁾	
1	8218 29	RCD slab box	
		Cable snake	
1	81906 40	Grey	
1	81906 41	Black	
1	86502 10	Power pole	
1	8218 30	Power pole backbox	

Installation examples

Power pole with accessory outlet tile and fixing bracket

Floor box lid and trim with floor box tile

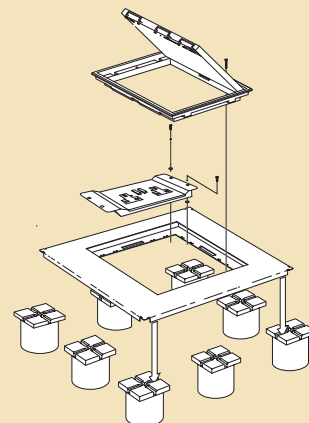
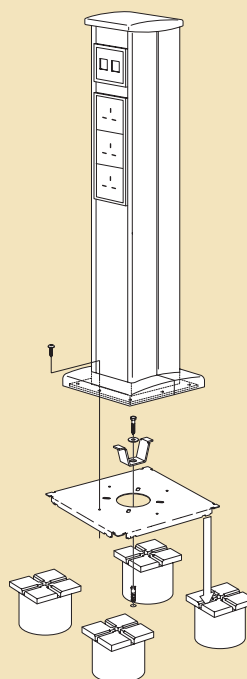

(1) For use with single socket outlet tile. Shown with Mosaic 13 A socket, Cat. No. 0741 40 (order separately). For the full range of Mosaic options, please refer to the current Legrand catalogue

Soluflex® cable floor system

technical information

■ Specification / technical data

Construction

The Soluflex cable floor system is constructed of a raised floor of tiles and supports with integrated cabling and connection points for telecoms, power and data

Materials

- The tiles are manufactured from pre-galvanised sheet steel in accordance with BS EN 10326
- The supports are made of polypropylene. Inflammability class B2 according to DIN 4102

Weights and measures

- Dimensions of tiles : 225 x 225 mm
- 4 different heights : 37 mm, 60 mm, 90 mm, 120 mm
Other heights available on request
- Weight of the Soluflex cable floor system : approx. 20 kg per m²

■ Load bearing data

- Point load per tile/support : 1500 Newton/25 mm²
- Equal divided load of 3000 kg per m²
- Minimum safety factor : $V = 1.71$

Acoustic

- **Flanking airborne sound insulation in accordance with ISO 717-1 : 1996**

Tested according to ISO 140-12 : 2000

Soluflex cable floor system + carpet tiles, without mineral wool underneath the partition wall : $D_{n,f,w} = 48$ dB

Soluflex cable floor system + carpet tiles, with mineral wool underneath the partition wall : $D_{n,f,w} = 48$ dB

- **Flanking impact sound insulation in accordance with ISO 717-2 : 1996**

Tested in accordance to ISO 140-12 : 2000

Soluflex cable floor system + carpet tiles, without mineral wool underneath the partition wall : $L_{n,f,w} = 49$ dB

Soluflex cable floor system + carpet tiles, with mineral wool underneath the partition wall : $L_{n,f,w} = 39$ dB

- **Vertical impact sound insulation improvement in accordance with ISO 717-2 : 1996**

Tested in accordance with ISO 140-8 : 1978

Concrete floor 140 mm + Soluflex

□ $L_w = 17$ dB □ $l_{lin} = 7$ dB

Concrete floor 140 mm + Soluflex + carpet tiles

□ $L_w = 24$ dB □ $l_{lin} = 12$ dB

■ Sound measurements

The sound measurements have been carried out in the laboratory of consultancy firm Peutz & Associates. The complete report can be obtained from our sales department

Safety

- Safety against short circuits : Soluflex is earthed (as long as 1 earthing tile is installed per 100 m²)
- Fire resistance : due to its low plenum height Soluflex is self-extinguishing
Tested according to BS EN 13501-1, class B(fl)S1-d0

Other characteristics

The Soluflex cable floor system feels extremely solid. Since the system is not adjustable in height, it needs no later adjustment

The grid layout of the system means the cables are perfectly parallel, and you can cross data cables at the required angle of 90°

■ **TNO-fire**

Fire propagation

Its low plenum height enables the cable floor system to be self-extinguishing

NEN-EN 13501-1

B(fi) S1-d0

NEN 1775 :

A - Inflammability - complies with the class T1 criteria for inflammability

B - Horizontal fire propagation : all heights
 maximum horizontal fire propagation = 0 cm, which implies a critical density of heat flow of more than 11 kW/m²
 Classification according to NEN 1775 : Class T1

NEN 6066 :

With (highest) heat flow supply of 50 kW/m² :
 (highest) normative smoke density smaller than 0.5 m⁻¹, which is very little smoke production in case of fire

DIN 4102 :

Resistance to fire in accordance with DIN 4102 Class B1

■ **Level floor**

The sub-floor must be dry, clean and level, suitable for laying carpet. If the floor is not level, it must be levelled before you start to install the Soluflex cable floor system. Please contact your floor specialist for professional advice

■ **KEMA-certificate**

Soluflex cable floor system has been certified by KEMA and meets the requirements for mechanical and electrical safety

Earthing

The cable floor system is automatically earthed, provided that 1 earthing tile is installed per 100 m². Install an earthing tile every 14 m length in gangways



Soluflex® cable floor system general installation instructions

■ Installing the Soluflex cable floor system

- Start with a dry, clean and level sub-floor that is suitable for laying normal carpet. If the floor does not meet these requirements, level it first
- Start in the corner of the room and click the tiles into the plastic supports. Leave a 10 mm gap between the wall and tile to allow for expansion. Continue to build the floor like this and cut fitting tiles or edge plates to size
- You are now ready to open the cable routes using your cabling plan. Make sure that the cables are not placed under proposed locations of filing cabinets or other furniture as this limits flexibility
- The corners of the tiles have small recesses to enable them to be lifted using a screwdriver. Once one tile has been removed, the others can be removed by hand
- Now place the power track or cables into the cable routes, taking into account any extra cabling requirements for future flexibility
- By installing more outlet boxes you will be able to realise extra connections without interruption later
- Dependent on the floor height being installed, a choice can be made from various (pre-wired) outlet units in or on the cable floor
- Earth the cable floor system every 100 m² by means of an earthing tile
- In stretched areas such as corridors, place an earthing tile at least every 14 metres
- The electrical installation should always be carried out by a qualified electrician in conjunction with the requirements of the latest wiring regulations
- To create 'islands', install steps with step corners to ensure a neat finishing of the system
- The ramp provides a constant transition from an existing floor to the Soluflex cable floor system
- The entire system can easily be dismantled and installed again as required, giving Soluflex a virtually unlimited life
- The finished installation can then be covered with rubber, stone, wood or carpet tiles
- Finishing with carpet tiles is advised for true flexibility and accessibility of the system

Ramp



Cable routes



Completed Soluflex installation

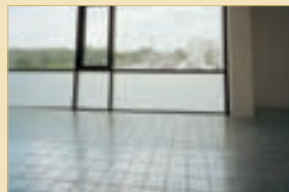

Finished example with carpet tiles



Soluflex® cable floor system dimensions

37 mm height

■ Dimensions (mm)

Tile

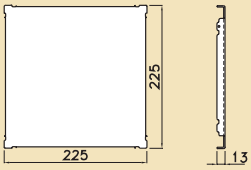

Support

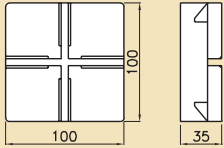

Double edge plate

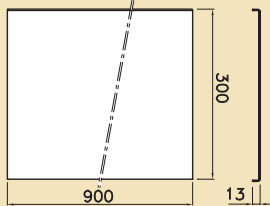

Single edge plate

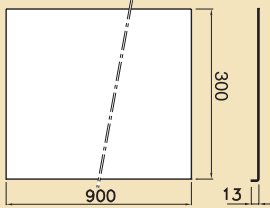

Step

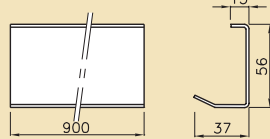

Step corner

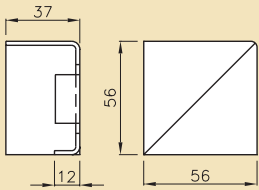

Ramp

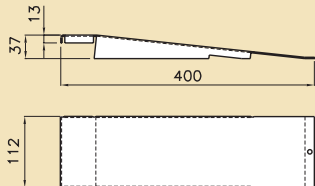

Earthing tile

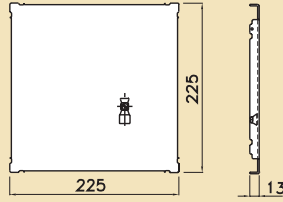

Cable outlet tile

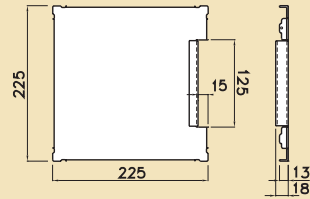

Chrome outlet grommet

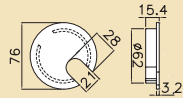

Accessory outlet tile

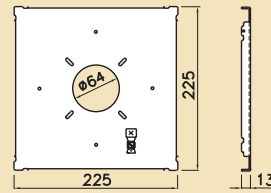

Fixing bracket

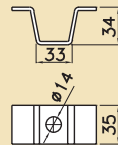

Built-in Mosaic unit

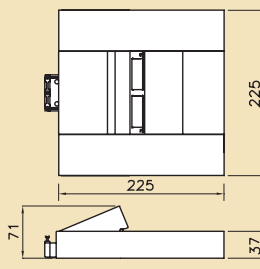

Soluflex® cable floor system dimensions

60 mm height

■ Dimensions (mm)

Tile

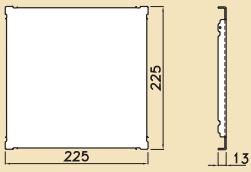

Support

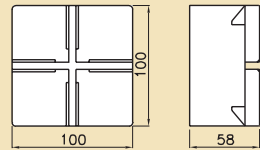

Double edge plate

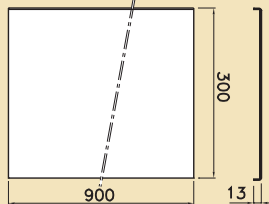

Single edge plate

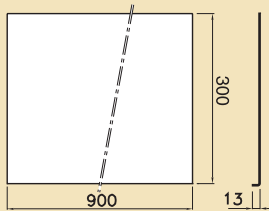

Step

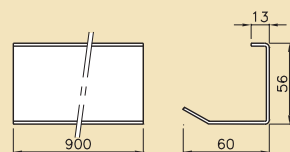

Step corner

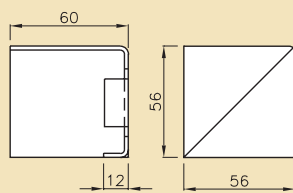

Ramp

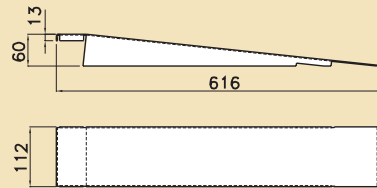

Earthing tile

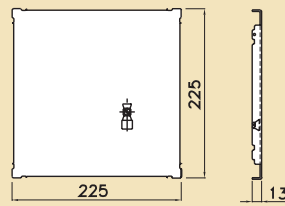

Cable outlet tile

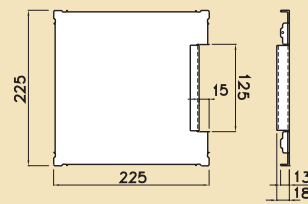

Chrome outlet grommet

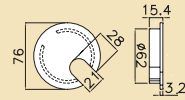

Accessory outlet tile

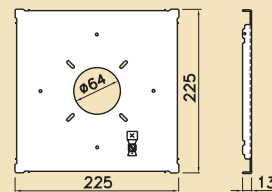

Fixing bracket

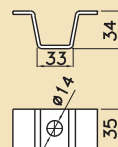

Built-in Mosaic power unit 2 x 240 V (empty)

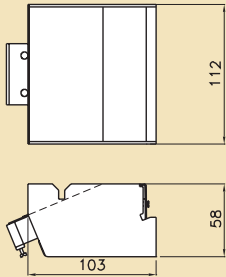

Built-in Mosaic data unit 2 x 2 data (empty)

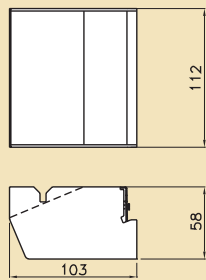

Floor box tile

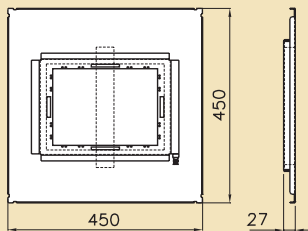

Soluflex® cable floor system dimensions

90 mm height

■ Dimensions (mm)

Tile

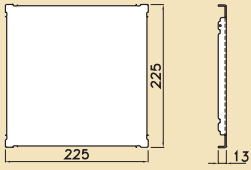

Support

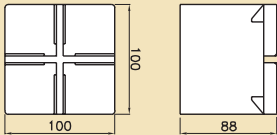

Double edge plate

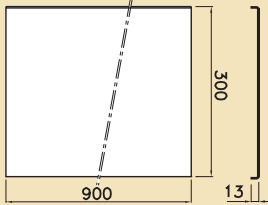

Single edge plate

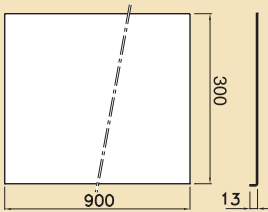

Step

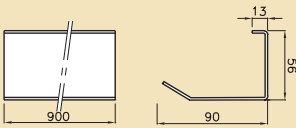

Step corner

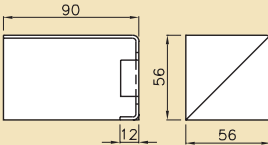

Ramp

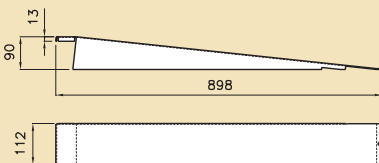

Earthing tile

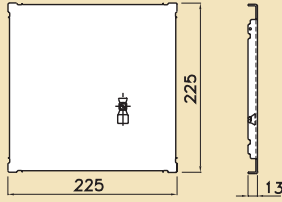

Cable outlet tile

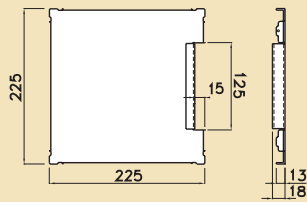

Chrome outlet grommet

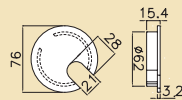

Accessory outlet tile

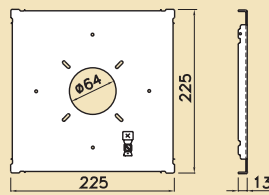

Fixing bracket

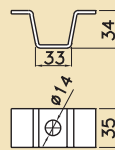

Floor box tile

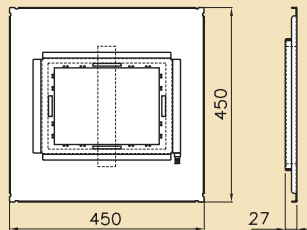

Soluflex® cable floor system dimensions

120 mm height

■ Dimensions (mm)

Tile

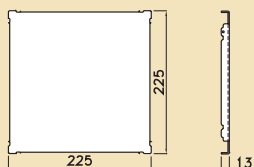

Support

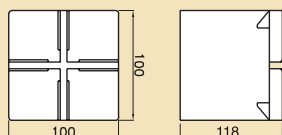

Double edge plate

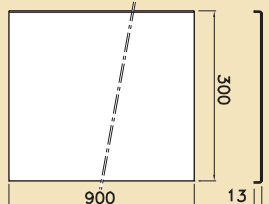

Single edge plate

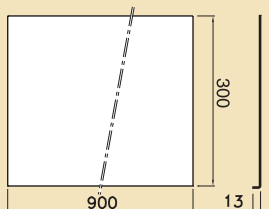

Step

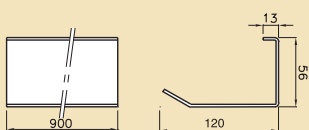

Step corner

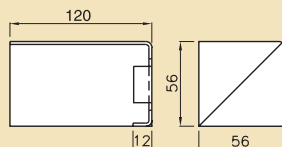

Ramp

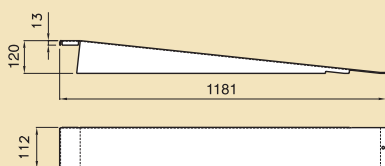

Earthing tile

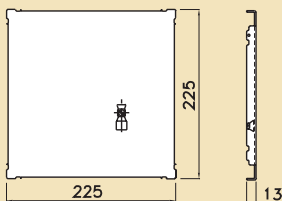

Cable outlet tile

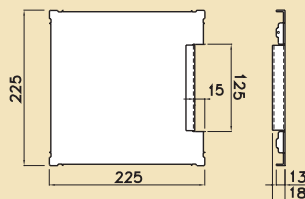

Chrome outlet grommet

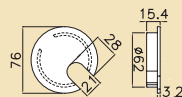

Accessory outlet tile

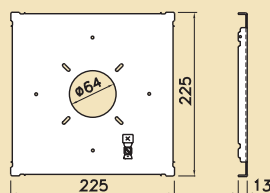

Fixing bracket

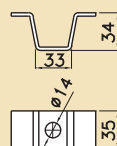

Floor box tile

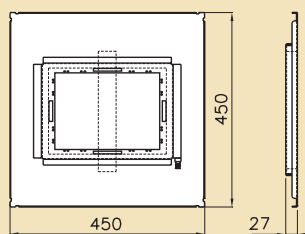

Arena-Walsall® power track system

standard

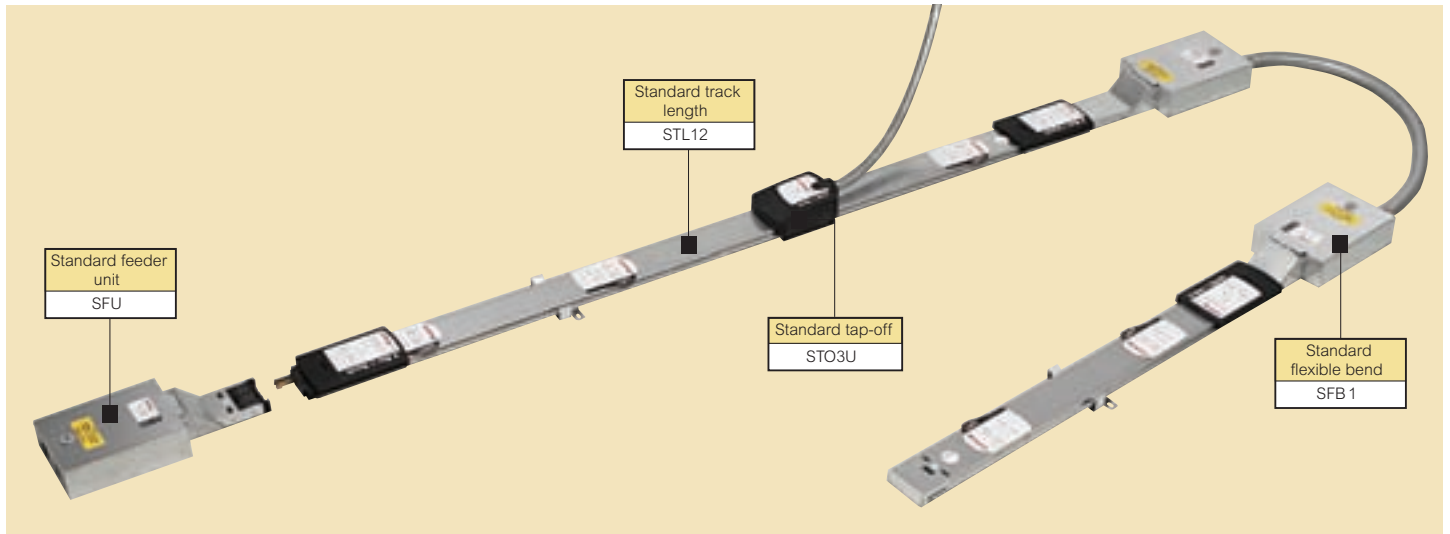

Dimensions and technical information (p. 34–35)

Two bar and earth 63 A power track system

Pack	Cat. Nos.	Track lengths and feeder unit
		Standard track lengths Supplied complete with hold down clamps Recommended spacing between two clamps no greater than one metre
1	STL12	1.2 metres, 4 tap-offs
1	STL18	1.8 metres, 6 tap-offs
1	STL24	2.4 metres, 8 tap-offs
1	STL30	3.0 metres, 10 tap-offs
1	STL36	3.6 metres, 12 tap-offs
		Standard feeder unit Supplied with one end cap to be fitted to track end
1	SFU	2 x 20/25 mm knockout entries Terminal capacity 16 mm ² maximum

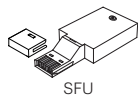
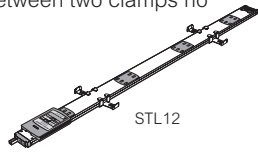

Pack	Cat. Nos.	Standard tap-offs
		All tap-offs conform to Section 607 of BS 7671 : 2001 Supplied with new cable colours to BS 7671 : 2001 amendment No. 2 'fixed wiring' These tap-offs can also be used with the dual circuit power track
1	STO3U	3 metres, unfused
1	STO3F	3 metres, fused
1	STO5F	5 metres, fused



Pack	Cat. Nos.	Flexible bends and tee units
		Standard flexible bend Comprises a length of 25 mm conduit with a plug-in feed at each end, pre-wired with 10 mm ² tri-rated cable Cable length = 1 metre Other lengths are available to special order Can be used as a bend or an offset
1	SFB1	
		Standard tee units Supplied with slider and one end cap
1	STUA	Left feed
1	STUB	Centre feed
1	STUC	Right feed
		Standard four way Supplied complete with slider and two end caps
1	SFW	

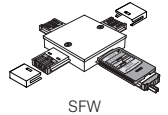
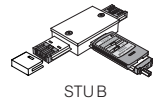
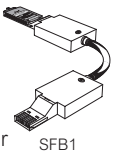

Pack	Cat. Nos.	Accessories
		Spare hold down clamp
1	SHC	
		Hanger brackets Vertical hanger bracket Horizontal hanger bracket
1	SVB	
1	SHB	
		Spare end cap
1	SEC	

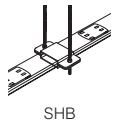
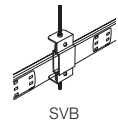
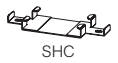

Standard power track is denoted by a white label with a black flash

Arena-Walsall® power track system

clean earth

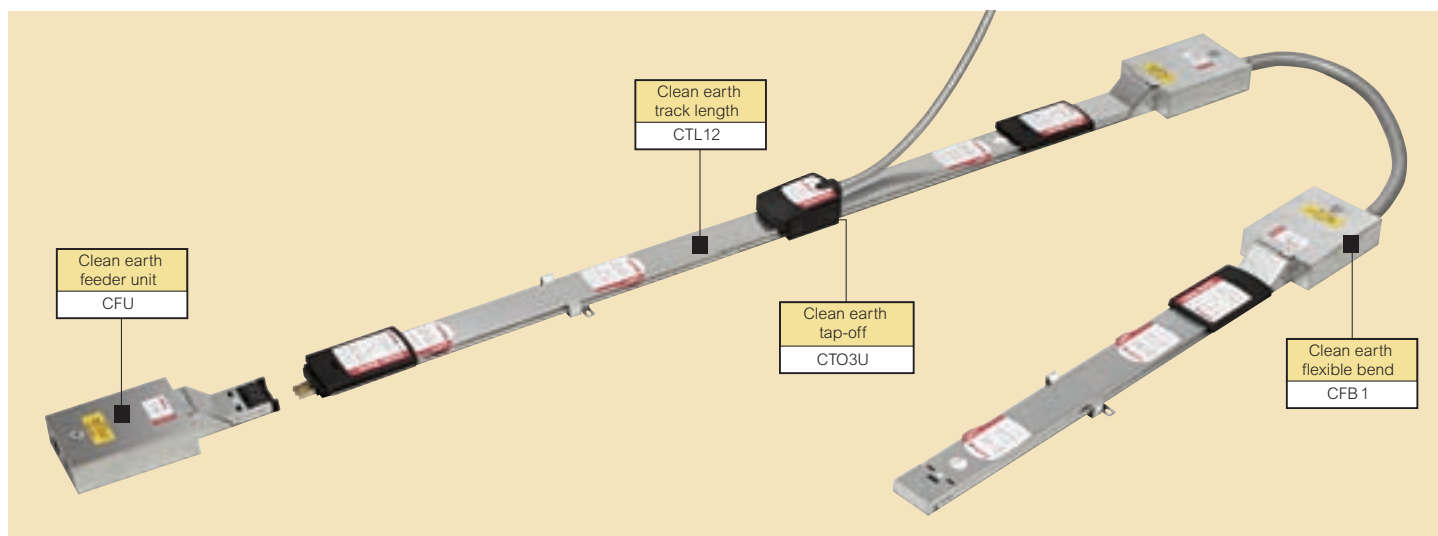

Dimensions and technical information (p. 34–35)

Three bar and earth 63 A power track system including an independent clean earth copper bar

Track lengths and feeder unit

Pack	Cat. Nos.	
1	CTL12	1.2 metres, 4 tap-offs
1	CTL18	1.8 metres, 6 tap-offs
1	CTL24	2.4 metres, 8 tap-offs
1	CTL30	3.0 metres, 10 tap-offs
1	CTL36	3.6 metres, 12 tap-offs

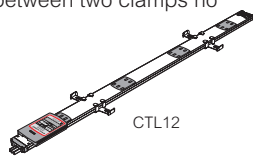

Clean earth track lengths

Supplied complete with hold down clamps
Recommended spacing between two clamps no greater than one metre

Clean earth feeder unit

Supplied with one end cap to be fitted to track end

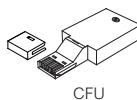

1	CFU	2 x 20/25 mm knockout entries Terminal capacity 16 mm ² maximum
---	-----	---

Clean earth tap-offs

All tap-offs conform to Section 607 of BS7671 : 2001
Supplied with new cable colours to BS 7671 : 2001 amendment No. 2 'fixed wiring'
These tap-offs can also be used with the dual circuit power track



1	CTO3U	3 metres, unfused
1	CTO3F	3 metres, fused
1	CTO5F	5 metres, fused

Flexible bends and tee units

1	CFB1	Clean earth flexible bend Comprises a length of 25 mm conduit with a plug-in feed at each end, pre-wired with 10 mm ² tri-rated cable Cable length = 1 metre Other lengths are available to special order Can be used as a bend or an offset
---	------	--

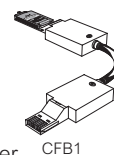

1	CTUA	Clean earth tee units Supplied with slider and one end cap
1	CTUB	Left feed
1	CTUC	Centre feed
1	CTUC	Right feed

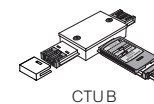

1	CFW	Clean earth four way Supplied with slider and two end caps
---	-----	--

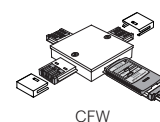

Accessories

1	SHC	Spare hold down clamp
1	SVB	Hanger brackets Vertical hanger bracket
1	SHB	Horizontal hanger bracket
1	SEC	Spare end cap

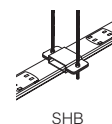
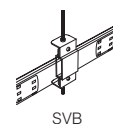
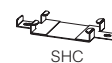

Clean earth power track is denoted by a white label with a red flash

Arena-Walsall® power track system

dual circuit

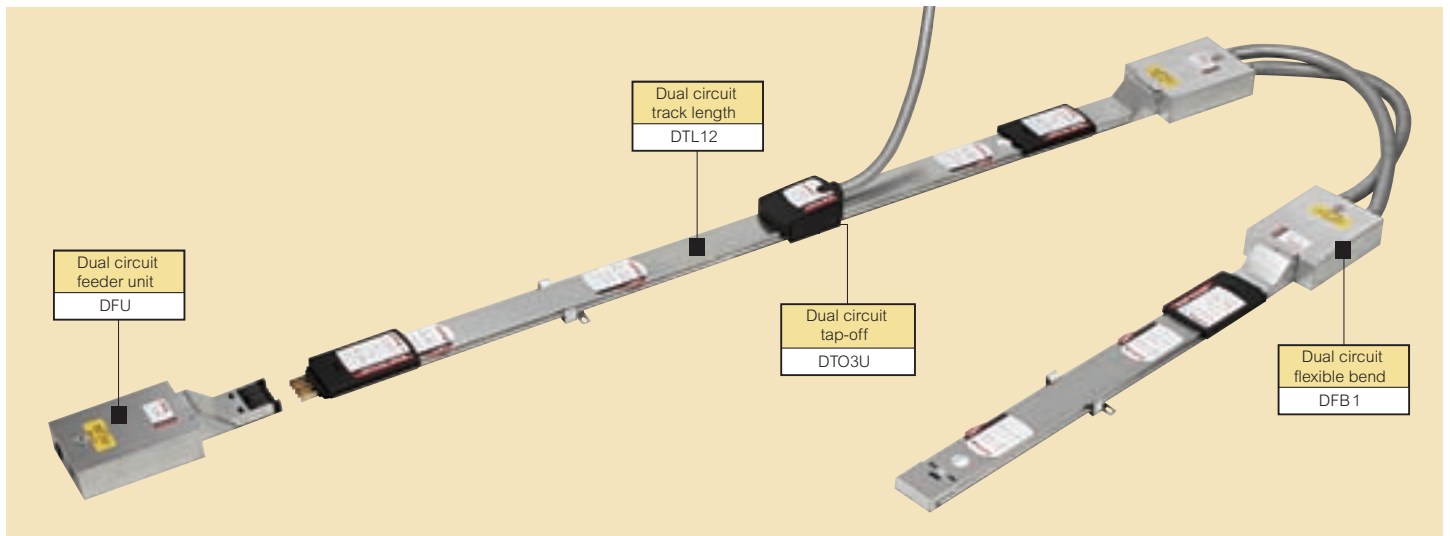

Dimensions and technical information (p. 34–35)

Five bar and earth 50 A power track system incorporating both standard and clean earth systems within one enclosure

Pack	Cat. Nos.	Track lengths and feeder unit
		Dual circuit track lengths Supplied complete with hold down clamps Recommended spacing between two clamps no greater than one metre
1	DTL12	1.2 metres, 4 tap-offs
1	DTL18	1.8 metres, 6 tap-offs
1	DTL24	2.4 metres, 8 tap-offs
1	DTL30	3.0 metres, 10 tap-offs
1	DTL36	3.6 metres, 12 tap-offs
		DTL12
		Dual circuit feeder unit Supplied with one end cap to be fitted to track end
1	DFU	2 x 20/25 mm knockout entries Terminal capacity 16 mm ² maximum
		DFU

Pack	Cat. Nos.	Dual circuit tap-offs
		All tap-offs conform to Section 607 of BS 7671 : 2001 Supplied with new cable colours to BS 7671 : 2001 amendment No. 2 'fixed wiring' These tap-offs must only be used with the dual circuit power track All tap-offs from standard and clean earth track can also be used
1	DTO3U	3 metres, unfused
1	DTO3F	3 metres, fused
1	DTO5F	5 metres, fused
		DTO3U

Pack	Cat. Nos.	Flexible bends and tee units
		Dual circuit flexible bend Comprises a length of 25 mm conduit with a plug-in feed at each end, pre-wired with 10 mm ² tri-rated cable Cable length = 1 metre Other lengths are available to special order Can be used as a bend or an offset
1	DFB1	DFB1
		Dual circuit tee units Supplied with slider and one end cap
1	DTUA	Left feed
1	DTUB	Centre feed
1	DTUC	Right feed
		DTUB
		Dual circuit four way Supplied with slider and two end caps
1	DFW	DFW

Pack	Cat. Nos.	Accessories
		Spare hold down clamp
1	SHC	SHC
		Hanger brackets Vertical hanger bracket Horizontal hanger bracket
1	SVB	SVB
1	SHB	SHB
		Spare end cap
1	SEC	SEC

Dual circuit power track is denoted by a white label with a black and red flash

Arena-Walsall® power track system

three phase

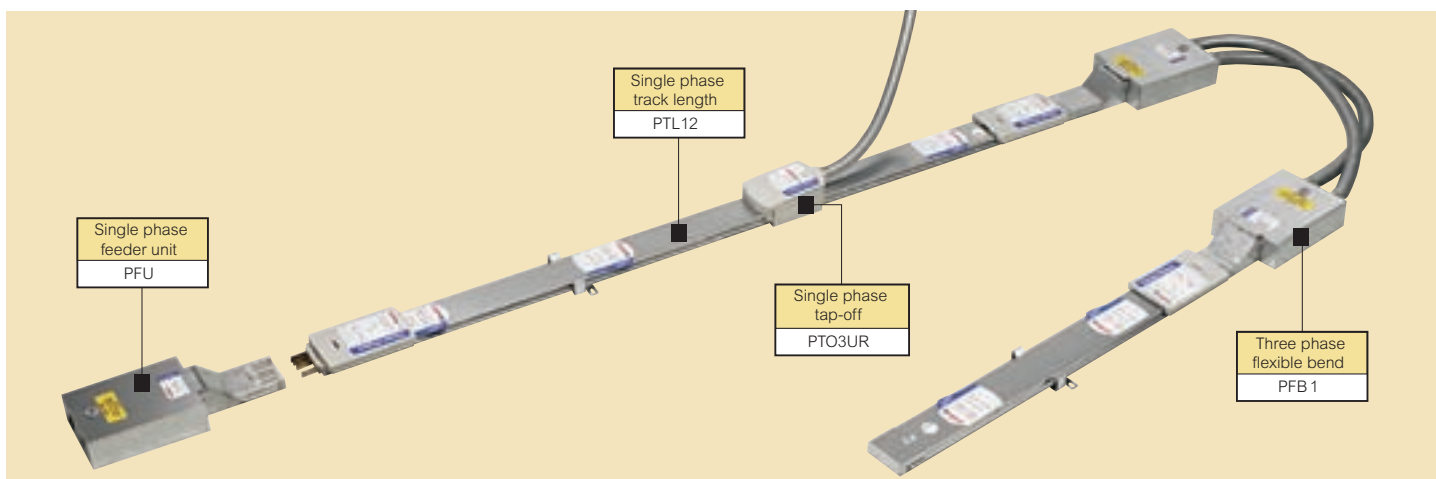

Dimensions and technical information (see p. 34–35)

Four bar and earth 50 A power track system. Three phased bars, one neutral bar and earth

Pack	Cat. Nos.	Track lengths and feeder unit
		Three phase track lengths Supplied complete with hold down clamps Recommended spacing between two clamps no greater than one metre
1	PTL12	1.2 metres, 4 tap-offs
1	PTL18	1.8 metres, 6 tap-offs
1	PTL24	2.4 metres, 8 tap-offs
1	PTL30	3.0 metres, 10 tap-offs
1	PTL36	3.6 metres, 12 tap-offs
		Three phase feeder unit Supplied with one end cap to be fitted to track end
1	PFU	2 x 20/25mm knockout entries Terminal capacity 16 mm ² maximum

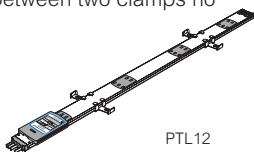

PTL12

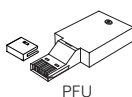

PFU

Pack	Cat. Nos.	Tap-offs for three phase power track
		Single phase tap-offs All tap-offs conform to Section 607 of BS 7671 : 2001 Supplied with new cable colours to BS 7671 : 2001 amendment No.2 'fixed wiring' These tap-offs must only be used with the 3 phase power track
1	PTO3UR	3 metres, unfused reconfigurable
1	PTO3FR	3 metres, fused reconfigurable
1	PTO5FR	5 metres, fused reconfigurable
		Three phase tap-off All tap-offs conform to Section 607 of BS7671 : 2001 Supplied with new cable colours to BS 7671 : 2001 amendment No. 2 'fixed wiring' This tap-off must only be used with the 3 phase power track
1	PTO3U	3 metres, unfused (L1, L2 and L3 connected)



PTO3FR



PTO3U

Pack	Cat. Nos.	Flexible bends and tee units
		Three phase flexible bend Comprises a length of 25 mm conduit with a plug-in feed at each end, pre-wired with 10 mm ² tri-rated cable Cable length = 1 metre Other lengths are available to special order Can be used as a bend or an offset
1	PFB1	
		Three phase tee units Supplied with slider and one end cap
1	PTUA	Left feed
1	PTUB	Centre feed
1	PTUC	Right feed
		Three phase four way Supplied with slider and two end caps
1	PFW	

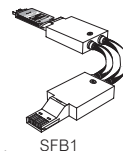

SFB1

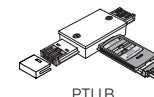

PTUB

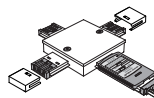

SFW

Pack	Cat. Nos.	Accessories
		Spare hold down clamp
1	SHC	
		Hanger brackets Vertical hanger bracket Horizontal hanger bracket
1	SVB	
1	SHB	
		Spare end cap
1	SEC	

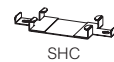

SHC

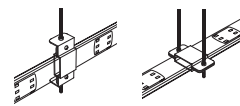

SVB

SHB



SEC

Three phase power track is denoted by a white label with a blue flash

■ Specification / technical data

Electrical data	
Rated current	63 A/50 A
Rated voltage	250 V/415 V
Frequency	50/60 Hz
Rated short circuit withstand	16 kA
Track conductor resistance - line and neutral	3 mΩ/m
Track conductor impedance	1.43 mΩ/m

Volt drops	
Line and neutral : track	2.86 mV/A/m
Tap-off (32 A - 4 mm ² cable)	10 mV/A/m
Flexible bend (10 mm ² tri-rated cable)	3.7 mV/A/m
Feed unit	0.3 mV/A/m
Track connector	0.4 mV/A/m

Earth fault loop	
Impedance : L+N track conductors	1.5 mΩ/m
Earth track conductor	1.2 mΩ/m
Tap-off (32 A - 4 mm ² cable)	33 mΩ (3 metre L/N/E)
Feed unit	0.3 mΩ
Track connector	0.4 mΩ
Flexible bend (10 mm ² tri-rated cable)	3.7 mΩ (1 metre L/N/E)

Mechanical data	
Number of conductors	PE + 2,3,4 and 5
Track conductor cross section area	13 mm ²
Incoming cable termination capacity	16 mm ²
Tap-off cable 32 A unfused	4 mm ²
Tap-off cable 13 A fused	L/N : 2.5 mm ² , E : 4 mm ²
Tap-off conduit	16 mm/20 mm diameter
Feeder conduit entry	20 mm/25 mm diameter
IP rating	IP 40 (when fully assembled)
Maximum profile height	47 mm including tap-off
Track height	17 mm

Material specification	
Track housing	Galvanised steel
Track conductors	High conductivity copper
Track insulator	Self extinguishing PVC extrusion
Sockets, track connectors, track ends	Nylon
Tap-off plugs	Nylon
End shutters and track shutters	Glass filled nylon
Tap-off / flexible bend cable	LSF/PVC
Tap-off / feeder and connector pins	Brass

■ Technical information

Certification

Asta Certified and tested to BS EN 60439-1 : 1999 and BS EN 60439-2 : 2000
Manufactured within a ASTA BEAB approved ISO 9001:2000 facility



IEE Wiring regulations

Legrand fully complies with BS 7671 : 2001

Section 607 requirements

All items comply with the relevant paragraphs of Section 607 of BS 7671 : 2001

■ Terminal block connections

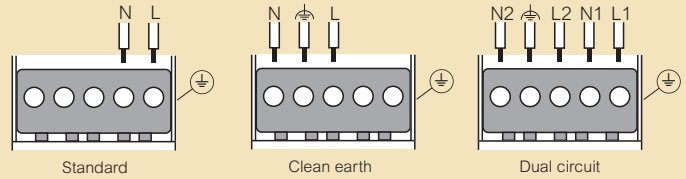

The three types above are compatible and an installation can be downrated from the dual circuit to either standard or clean earth in mid-run by means of a flexible bend or direct connection (see opposite)

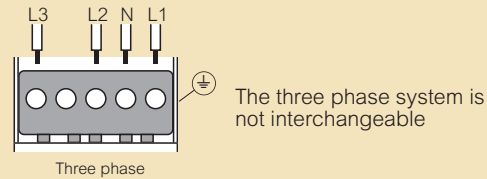

■ Track length

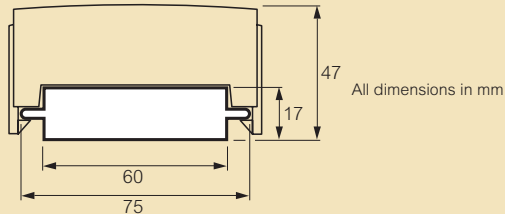

Overall height : 47 mm with feeder unit and tap-off

■ Feeder units

Two – 20/25 mm knockout entries
Terminal capacity 16 mm² maximum
Supplied complete with terminal block, lid and turnbuckle fastener and one end cap

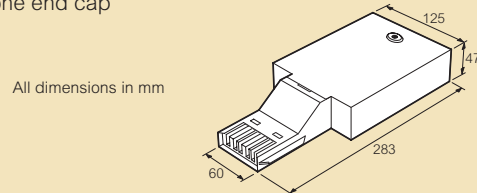

■ Tap-offs

Section 473-02-02 of the Wiring Regulations require any conductor exceeding 3 m in length to have a fault current protective device (e.g. fuse) at the point where current carrying capacity is reduced (tap-off plug)

All tap-offs over 3 m will be supplied with a BS1362 13 A fuse fitted within the plug

If the system is to be protected by a 32 A breaker then unfused tap-offs exceeding 3 m may be specified at time of order
Other pre-wired tap-off lengths are available on request

Unfused tap-offs are rated at 32 A

Fused tap-offs are supplied with a standard BS1362 13 A fuse

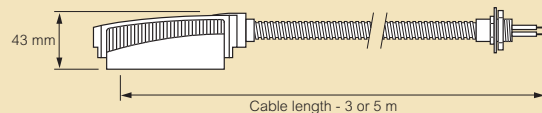

Tap-off length refers to the cable and not the conduit length
The conduit is 250 mm shorter than the cable length

Tap-offs for three phase power track

Single phase tap-offs

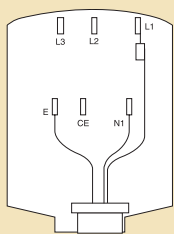

PTO3FR/PTO5FR
(fused)

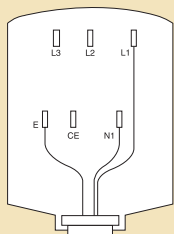

PTO3UR
(unfused)

Three phase tap-off

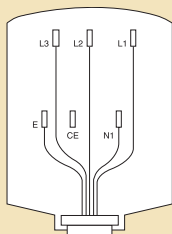

PTO3U
(unfused)

Tees and four ways

Supplied complete with slider, lid, turnbuckle fasteners and end cap(s)

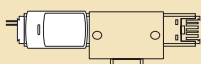

Left feed tee unit
Component Cat. No./A

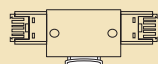

Centre feed tee unit
Component Cat. No./B

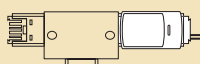

Right feed tee unit
Component Cat. No./C

Flexible bends

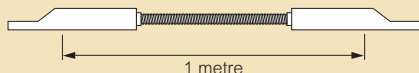

1 metre

End cap

Cat. No. SEC

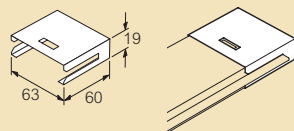

All dimensions in mm

Hold down clamp

Each power track length is supplied already fitted with sliding clamps.

- 2 clamps on each 1.2, 1.8 and 2.4 metre length
- 3 clamps on each 3.0 and 3.6 metre length

All dimensions in mm

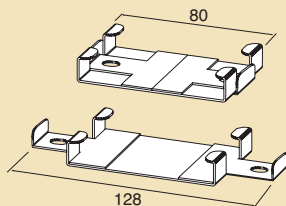

Vertical hanger bracket

Supplied in two parts complete with clamping screws (A)

Use one M8 threaded rod (B) and four M8 nuts (C) (one above and below each bracket flange)

Recommended spacing between vertical hanger brackets is 1 metre maximum

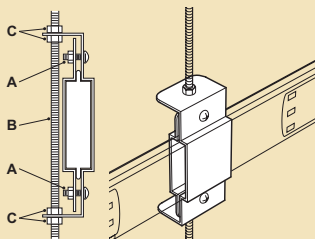

Horizontal hanger bracket

Supplied in two parts

Use two M8 threaded rods (A) and four M8 nuts (B) (one above and below each bracket flange)

Recommended spacing between horizontal hanger brackets is 1 metre maximum

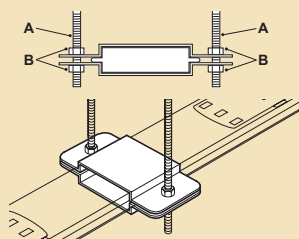

Typical Layout

The example opposite shows a typical layout consisting of numerous service outlet boxes with both standard and clean earth sockets in the call centre, two boxes with just clean earth sockets (fax, photocopier, etc) and boxes with standard sockets in the meeting rooms. Boxes with both standard and clean earth sockets can be fed with a dual circuit tap-off into a dual circuit track. The two clean earth boxes can be fed from the dual circuit track with just a clean earth tap-off

The system can then be upgraded by connecting standard track on to the dual circuit track by means of a flexible bend or direct connection. The continuing circuit is then restricted to a standard two bar and earth. This will save the contractor time and money by eliminating the need for extra cable and feeder units that would be required with separate systems

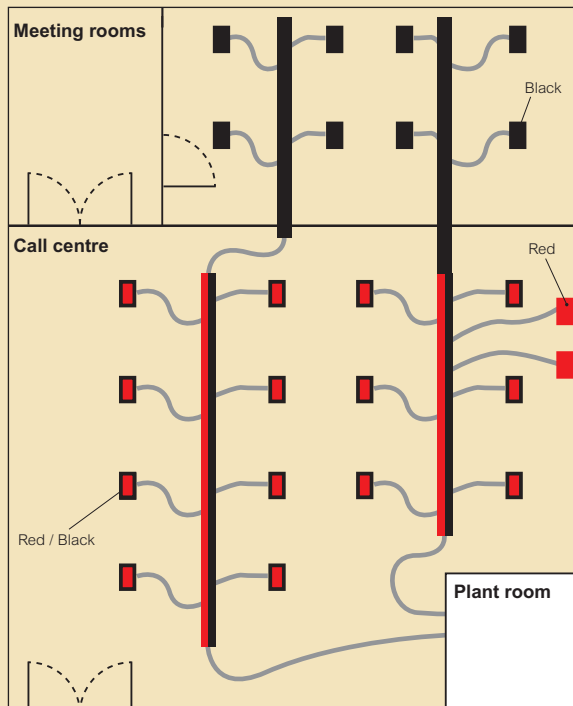
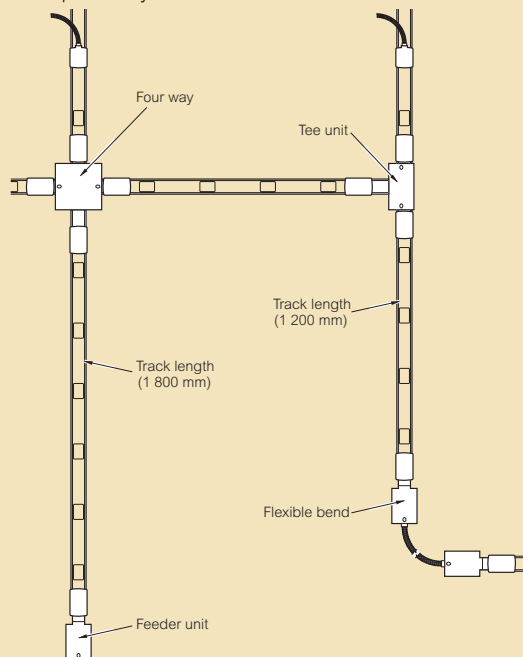

- 3 compartment service outlet box complete with 1 standard twin socket and 1 clean earth red twin socket.
- 3 compartment service outlet box complete with 2 clean earth red twin sockets.
- 3 compartment service outlet box complete with 2 standard twin sockets.

Soluflex and the Legrand logo
are registered trademarks of the
Legrand group of companies.



LEGRAND ELECTRIC LIMITED
Great King Street North, Birmingham, B19 2LF
Tel : 0870 608 9000 Fax : 0870 608 9004

Customer Services :
Tel : 0845 605 4333 Fax : 0845 605 4334
E-mail : legrand.sales@legrand.co.uk

Technical Support :
Tel : 0870 608 9020 Fax : 0870 608 9021
E-mail : technical.uk@legrand.co.uk

Website : www.legrand.co.uk